

# Tension Fabric Pop-Up Display

## Easy Set Up Instruction

(Please read before set up)



<http://www.prints-mart.com>

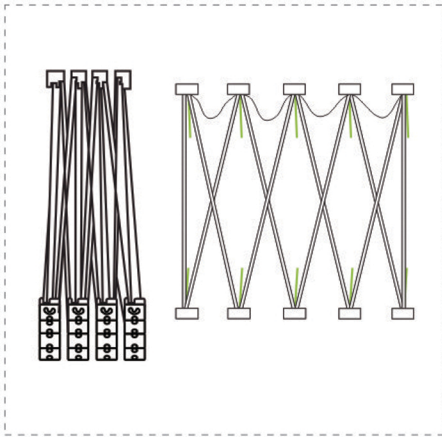

1. Stretch frame to size. Make sure webbing is not wrapped around grey locking arms.

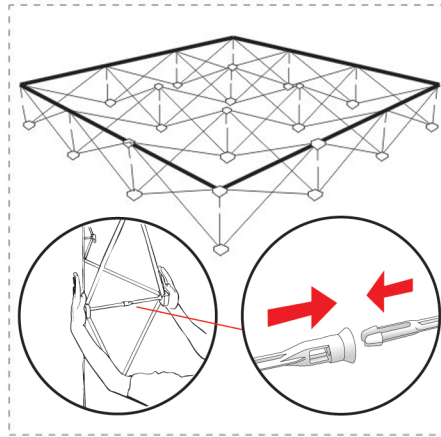

2. Align all grey locking arms and snap all grey locking arms into place.

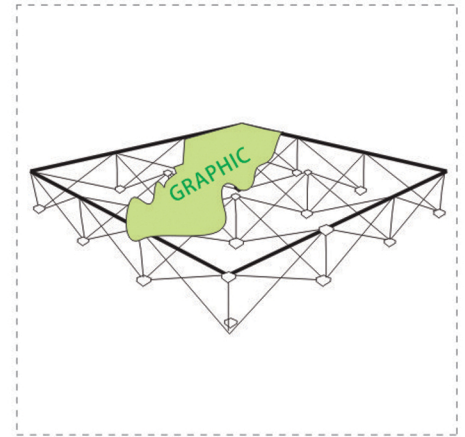

3. Graphic attaches to frame with Velcro. Start in one corner and move on to the next.

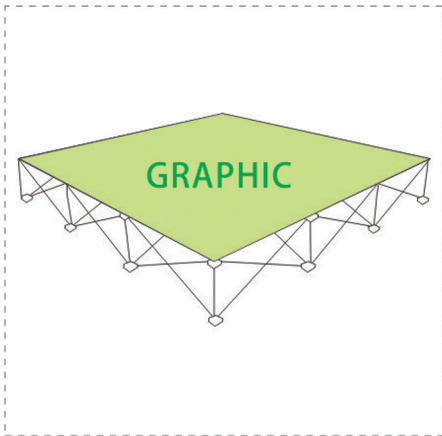

4. Graphic application is complete if no wraps.

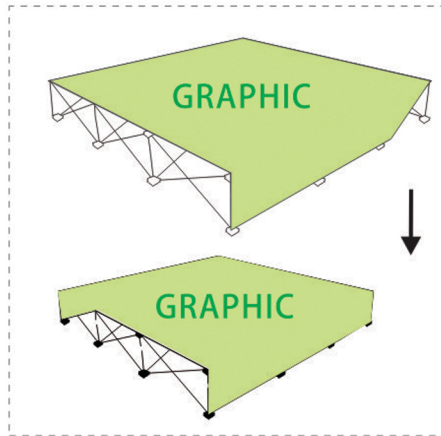

5. Pull end caps down to corner of frame and attach. Then attach other corner. Repeat on opposite side.

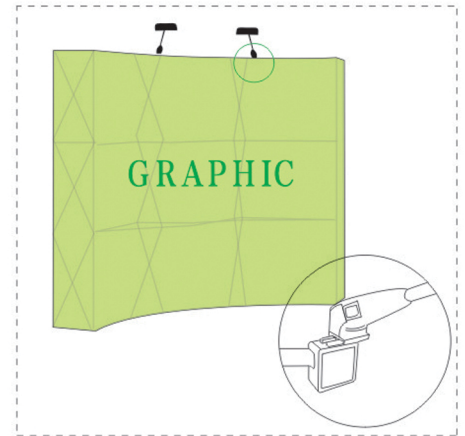

6. Attach the spotlights to the top of the display.

### To ensure quality, please note:

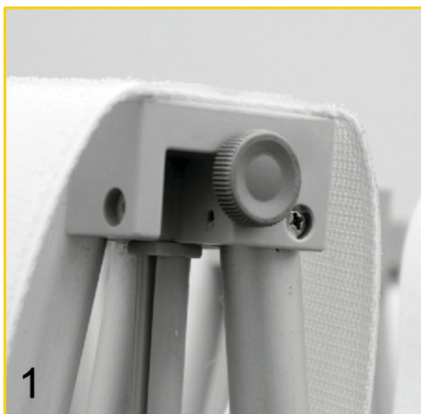

If the ground is not level, screw the rotary button to adjust the support leg to make the display upright.

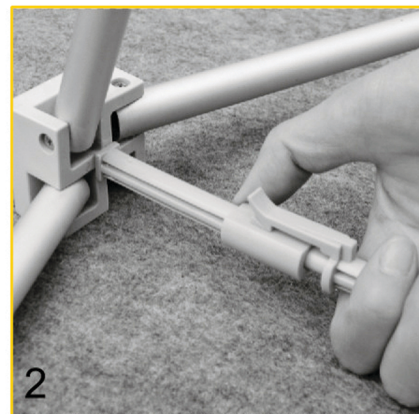

When disassembling, ensure that the arms are unlocked and aligned. If not, the arms will snap when pressure is applied.



Website: [www.prints-mart.com](http://www.prints-mart.com)

(Any Enquiry or Quote) E-mail: [order@prints-mart.com](mailto:order@prints-mart.com)

Tel: (852)3168-6995 Fax: (852)3741-7896

Address: Unit 1305 Hang Wai Industrial Ctr. Blk B 6 Kin Tai St. Tuen Mun, N.T. Hong Kong

